

This manual holds description on separate
part numbers and spare parts!



2box® Rack stand manual Mk2 1.0

This manual holds description on separate
part numbers and spare parts!



2box Rack Stand Manual

Page 3	Introduction and parts list
Page 4	Mounting the feet and the vertical legs
Page 5, 6	Mounting the horizontal tubes
Page 7	Assembling the holders
Page 8	Mounting the pads and the snare
Page 9	Mounting the hihat stand
Page 10	Mounting the kick
Page 12	Mounting the cymbals
Page 13	Mounting the unit
Page 14	Adjusting the stand to fit your playing style
Page 15	Complete set up



Your 2box kit comes in two boxes. The stand box holds the parts needed to erect the stand. The pedal box contains the snare and hihat stands plus the kick drum pedal. A third box holds the drumIt Five, all pads and cymbals, the cables with velcro and the kick holder.

Parts included in the stand box:

- 2 10140 Long curved bar
- 2 10141 Medium curved bar
- 6 10131 Tom/cymb/unit holder
- 3 10137 L-rod for tom pads
- 1 10160 Hihat holder
- 4 10245 Rubber feet
- 2 10159 Cymbal hex-rod assembly
- 2 10246 Long vertical tube
- 2 10247 Short vertical tube
- 1 10166 Tuning key
- 2 10173 Rubber feet heel
- 1 10174 Rubber feet hihat
- 1 10175 Rubber feet kick pedal
- 1 10254 Ball beater for kick pedal
- 1 10305 Unit holder with two tension rods

Parts included in the pad set box:

- 3 10021 10 inch tom pads
- 1 10014 12 inch snare pad
- 1 10026 14 inch kick pad
- 2 10200 Cymbal pad
- 1 10222 Hihat pad
- 1 11002 Cable set with velcro
- 1 10069 Kick holder assembly
- 1 11001 DrumIt Five unit with power adaptor

Parts included in the pedal box:

- 1 10170 Kick pedal (beater in the stand box)
- 1 10171 Hihat stand
- 1 10244 Snare stand





Mounting the tubes and the vertical legs

When you erect the stand for the first time, there will be some mounting of parts to be done. Please be patient. With many of the parts you will only need to do this once. For transportation you will find the stand can easily be folded together, therefore negating the need to assemble the stand again. The only tool you will need to build the stand is the included drum tuning key.



10255 Rubber foot

Mount the feet onto the long and short straight tubes, as shown in the image. The rubber feet are designed to fit snugly into the tube, so you may need to turn the rubber part around until you find the correct fit. (1)

(1)

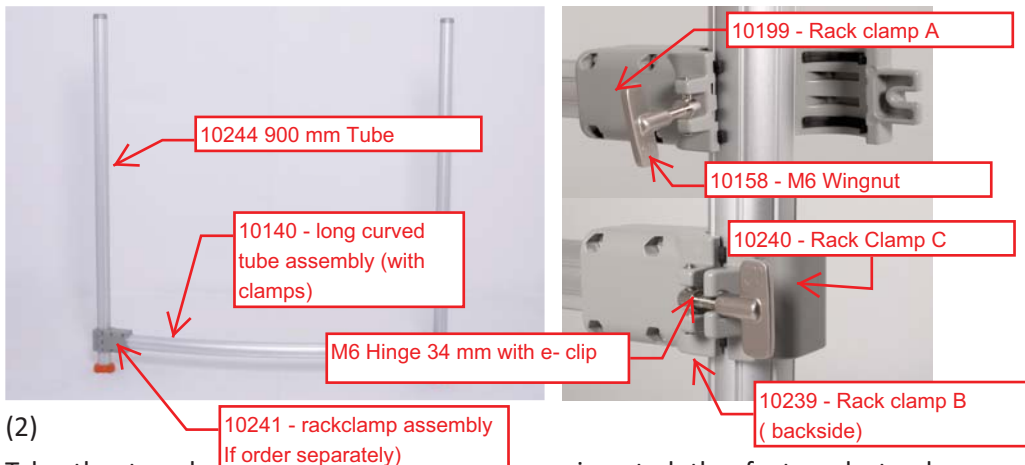

(2)

Take the two longest tubes once you have inserted the feet and stand them straight up. Of course if your floor is not completely flat you may wish to attach one leg at a time. Take one of the longer curved tubes (of which there are two) and turn it so the bow is facing inwards. Open the clamps attached to both ends and place the upright tubes into the clamp and tighten. This inward facing tube needs to be roughly four inches (10 cm) above the floor. Later you will find that you need to fine tune the height of this bar, once the bass drum and kick pedal are attached. (2)

Important note. It is not necessary to over tighten the clamp screw. Thanks to the rubber inserts in the clamp you will find there is sufficient friction to hold the parts in place.

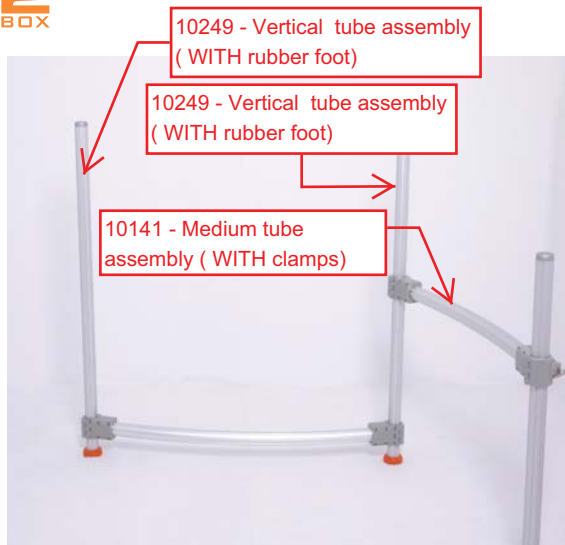

Take one of the shorter curved tubes, of which once again there are two. Undo the clamps that are attached to the ends and fit one of the clamps to the middle of the right upright tube. You will then need to take one of the shorter straight tubes and attach it to the other end of the shorter curved tube as shown in picture 3.

(3)

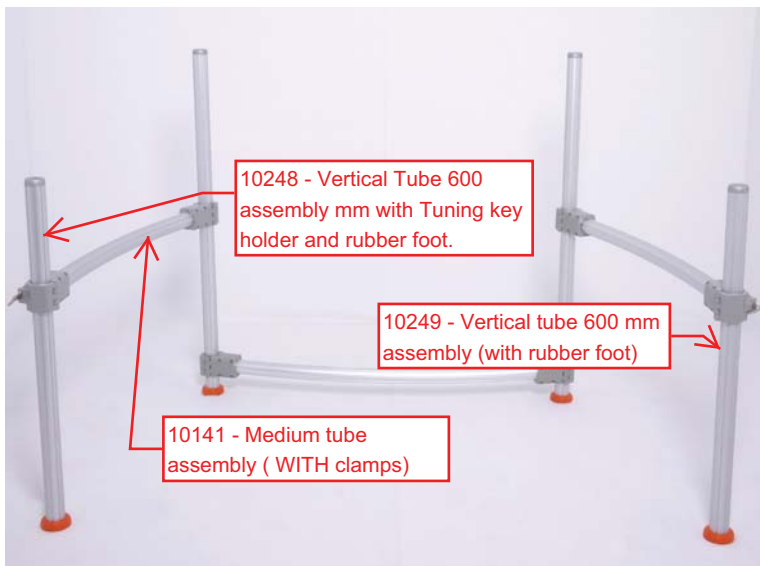

(4)

Repeat the process in picture three to attach the left arm and leg. Please do not tighten the clamps too tightly as when you are attaching your hi-hat stand you may need to adjust this arm up or down. (4)



(5)

Lastly, take the last long curved tube and mount it on the stand. This needs to be roughly four inches (10 cm) from the top of the stand, with the bow facing outwards. Later on you may wish to slide this top bar up or down to suit your playing style. (5)



Assembling the holders

The stand is designed to use the same bracket with the hex-rod receiver for all pads and cymbals except the kick and the Hi-hat.

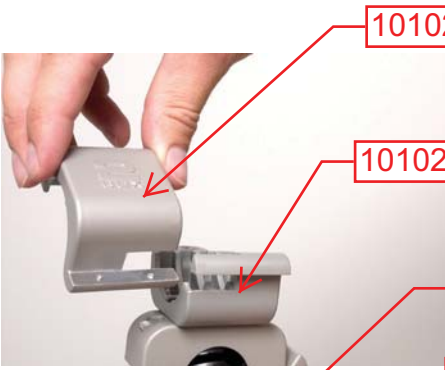

(7)

10102B - Bracket

10102A - Bracket

Unscrew the tension screw from the bracket and open up the bracket, slide the lower bracket apart. with the hex-rod receiver on the tube and slide in the lower part again, insert the tension

10128B - Tom holder house

10128A- Tom holder house

will most probably adjust the positions of the holders on the tube when (7, 8)



(8)

10130 - Tom holder ball

10137 - Tom L-Rod

All parts assembled: 10131 - Tom/Cym holder assembly



(9)

10137 - Tom L-Rod

Loosen the tension on the wing nut before you attempt to slide the L-rod into the black nylon ball. Adjust the angle of the L-rod to your desired position and tighten the wing nut. If you wish the pad to have less bounce when striking the pad, please move the pad closer to the bracket. (9)



Mounting the 10 inch pads



(10)

10061 - 10" floating rim

Mount two of the pad holders onto the upper curved bar, so they allow the two ten inch pads to sit beside each other. Once again we are sure you will eventually adjust this to suit your playing style. Take the L-rod and place the short length of the L-rod into the pad. Tighten the pad onto the L-rod. Now with the hole in the black nylon bar in the holder facing you, insert the L-rod into it and tighten the large wing nut to a position that suits you. Follow the same procedure for mounting the second and third Tom. The third tom should be mounted on the right hand curved tube. (10)

10081 - 12" floating rim

10030 - Tension rod washer

Mounting the 12 inch snare pad



(11)

Mount the 12 inch snare pad in the separate snare stand cradle. Tighten the cradle by turning the large black wingnut. (11)



Mounting the Hi-hat stand

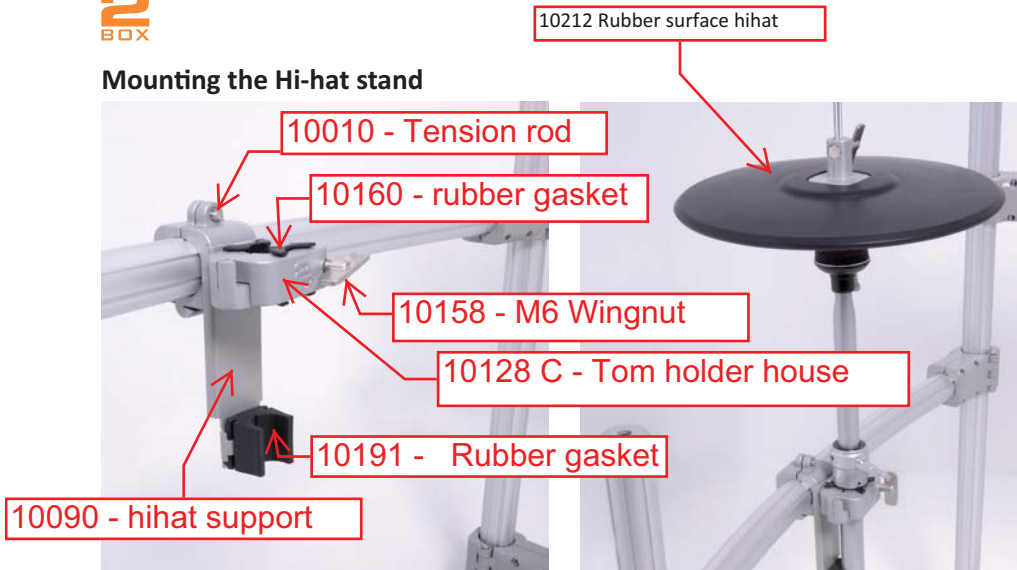

(12)

First mount the holder for the hihat stand onto the left side curved tube, as in picture 12. Next, the thin knurled hihat rod needs to be screwed into the corresponding screw thread in the bottom part of the hihat stand. Now slide the upper outer part of the hihat stand over the rod and tighten the screw located at the top of the bottom part of the hihat stand. On the pedal plate you will see two chrome arms that need to be inserted in holes on both sides of the outer part of the stand at the bottom, please see picture 13. Put the upright part of the hihat stand within the hihat holder you already have attached to the stand, and tighten the clamp around it gently. We advise gently, as later, you are bound to want to adjust the position of the hihat stand to your sitting position.



(13)

The hihat receiver shall be put on the hihat feltwasher prior to mounting the hihat pad.

Please note: Hihat must be calibrated when connected to the Unit the first time. See DrumIt Five user manual for calibration instructions.



10221- Hihat receiver assembly



Mounting the 14 inch kick drum

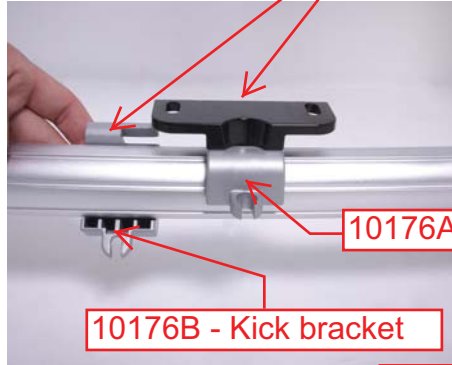

(14)

10099 - kick bracket assembly

10176A - Kick bracket

10176B - Kick bracket

10040 - Kick holder

10010 - Tension rod

10127 - Wing screw

10168 - Stop screw

10177 - Nut

10165 - Rubber stop

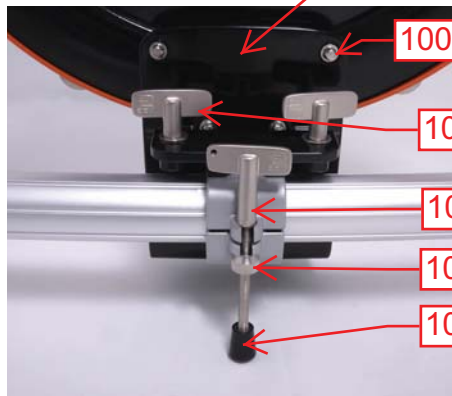

(15)

10254 - Ball beater

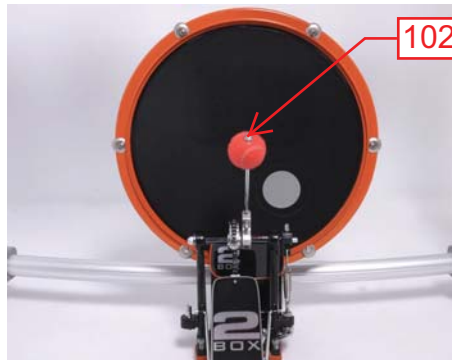

(16)

The kick drum mounting consists of three separate parts and three wing screws, one being longer with a rubber feet at the bottom of it. Mount the bracket as shown in picture 14 onto the bottom tube (this plate will be you if you are sitting at your drum kit). Put the long screw onto the back of the bracket as shown in picture 15. Once again tighten this just hard enough to keep it in place. (14) mounted on the tube. The fitting is

the rest of the mounting brackets for the kick drum. The kick holder box a back plate that screws to the back of the kick holder. (15) These screws can be tightened with the drum key provided. Once securely the kick drum holder the holder (14) mounted on the tube. The fitting is der by placing the two remaining wing screws into the threads provided, and tightened.

At this time you can alter the angle h to sit at. Next connect the kick drum pedal to the front of the bracket underneath and at bottom of the kick drum. Now push down gently on the curved lower tube and tighten everything into place. The rubber on the wing nut at the back should be in contact with the floor. (14,15,16)

Important note
We strongly advise you to use the ball beater provided when using a mesh head on the kick drum. Using a harder beater will damage the mesh head, and will not be covered by your warranty.



Finally mount the beater to the shaft of the pedal and adjust the height within the cut out area of the foam. (14, 15, 16)



(17)

Mount the beater in the hole and make sure the beater is hitting above the sensor and is within the cut out area of the foam before tightening this screw. (17)



(18)

With this screw (in the red ring) you adjust the height of the pedal plate. If set too low the pedal plate might accidentally hit the base of the pedal and cause unwanted acoustic noise. When the right position is set make sure to tighten this screw very hard. (18)



(19)

Later revisions of kick pedal holds an extra allen screw to secure the position of the pedal. (19)

UNDER NO CIRCUMSTANCES SHOULD YOU ALLOW THE BASS DRUM BEATER TO STRIKE THE SENSOR IN THE MIDDLE OF THE PAD. SHOULD YOU DO THIS YOUR WARRANTY WILL NOT COVER A REPLACEMENT!



Mounting the cymbals

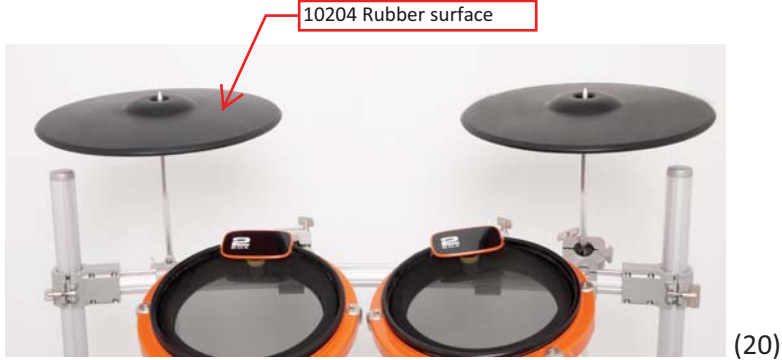

(21)

As with the mounting brackets for the pads, the cymbal brackets are assembled in just the same way. Traditionally you would mount the brackets to the left and right of the two toms in picture 20. However as this is free to put them where ever you wish. The same goes for the height of the cymbals. Lastly place the hard black cymbal washer on the top of the cymbal hex-rod, next the fat felt washer, lastly place the cymbal on top. There are no need for wing nuts to hold the cymbals in place, as the weight of the cymbal is quite adequate to keep it in place.

10131 - Tom/Cymbal holder assembly



Mounting the unit

With this new generation of the rack stand we suggest mounting the unit on the smaller left or right upright legs to be the best solution, but once again you may mount it wherever you wish. The mounting bracket fixes to the stand in just the same way as the toms and cymbal holders, see picture 22. The DrumIt Five unit fixes to the plate that holds the unit as shown in picture 23. Under no circumstances use any other screws than those supplied, to fix your unit to the plate. Using other screws runs the risk of seriously damaging your unit, and is not covered by your warranty. (22, 23, 24)

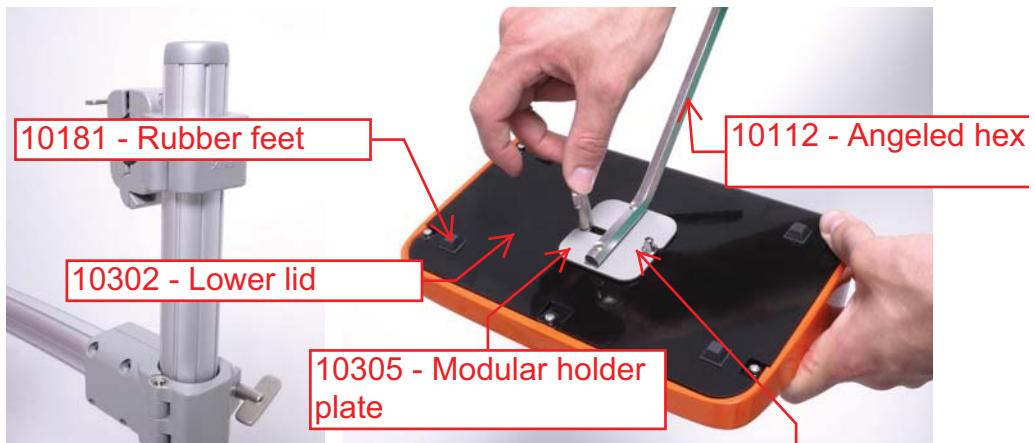

(22)

(23)

10306 - Unit holder with
10010 - tension rods
assembly

Please note: Never use
other screws than those
screws are used there
is a risk damaging the
circuit board inside the
unit. (23)



(24)

10301 - Upper lid

10303 - Panel



Adjusting the stand to fit your playing style

If you have followed all the previous instructions, you should now be able to sit at your kit, and adjust/tighten all brackets and screws so the pads/cymbals stay where you want them to be to suit your playing style. Once again, please do not over tighten the clamp screw that holds all the uprights tubes and horizontal tubes together.

Connecting the cables to the pads/cymbals

In the box you will find cables of differing lengths. These are provided so that the pads that are furthest away from the unit will need a long cable, and pads/cymbals that are close to the unit will use the short cable. There are also Velcro cable ties in the box to keep your cables neatly and tidily in place against the stand.

Power supply

Before connecting the power supply to your unit, check that it is the correct voltage for your country. This is purely a cautionary measure. Once you have established the voltage is correct, plug it into the back of the unit and switch on.

Play the kit

Your drum kit is now ready to be used in battle. The system is set to a factory default setting just to get you going. All trigger settings for pads and cymbals are set to a medium. Depending on your playing style you may wish to fine tune these settings. To do this we advise you to read the trigger adjustment section of the DrumIt Five owners manual. Please read this section carefully as there are some good advice to help you find the trigger setting suitable for your particular playing style. There is also some good tips and suggestions on the FAQ page at the 2box website. This is a professional system and it will take a little time for you to get use to it and achieve the best triggering response for your playing style.

Final word

We truly hope you enjoy your 2box system, and that it gives you many hours and years service. All of us here at 2box would like to thank you for purchasing your 2box drumIt Five kit, and we assure you, that we will continue to improve the system for your enjoyment. Have fun!



There is a hole in one of the bar to hold the tuning key in place when not in use.

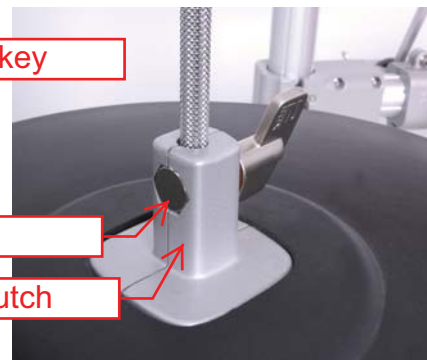

10103B - Tube end cap with hole

The stand design allows the kick to be mounted in different angles.



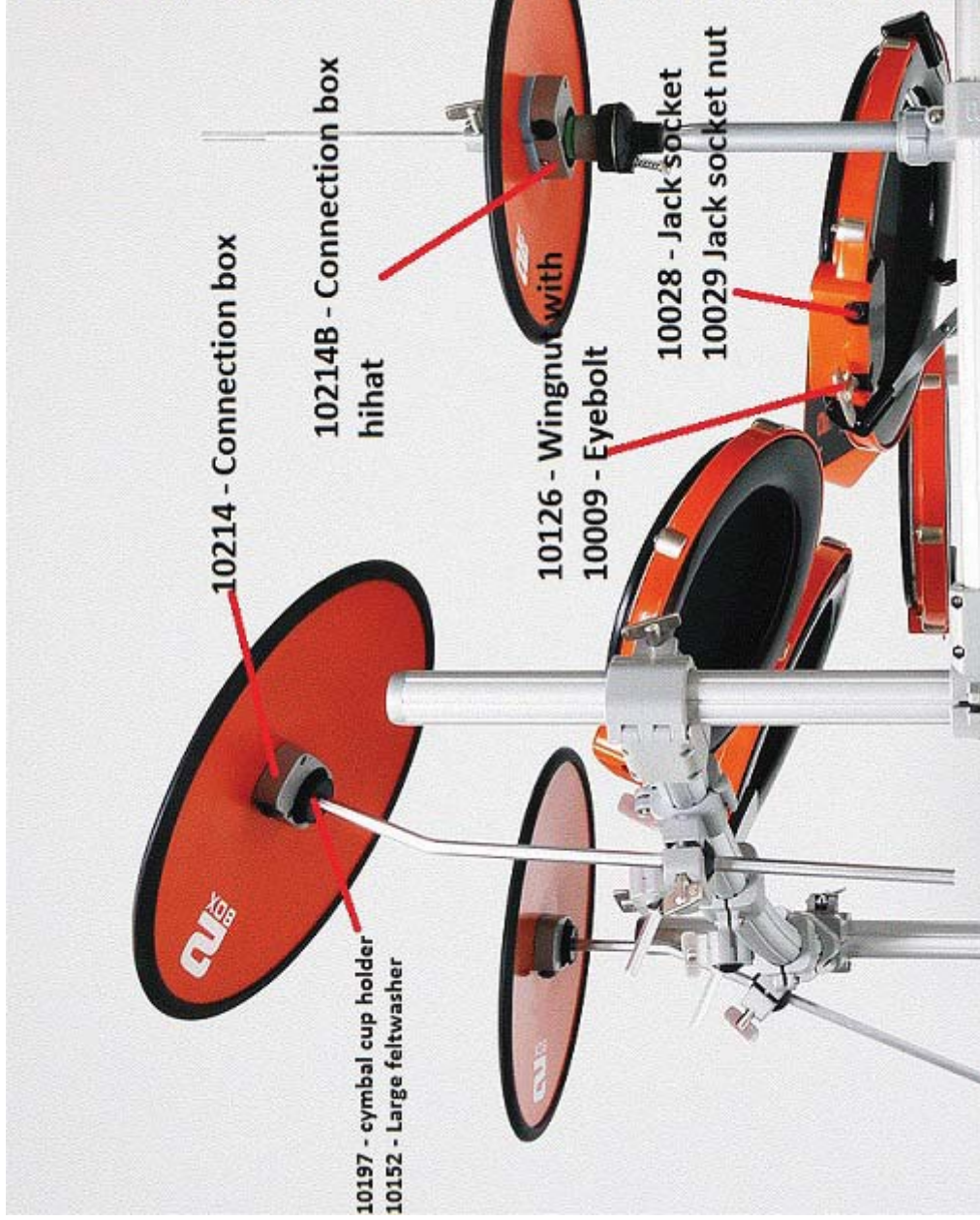



More information at www.2box.se

Specifications are subject to change without prior notice.

DrumIt and 2Box are trademarks owned by 2Box AB

Designed in Sweden. Made in China

Patent pending